

LASER WELDING - HERE'S HOW IT WORKS

LASER is an acronym for "Light Amplification by the Stimulated Emission of Radiation" which produces a sharp, focused light beam that melts a very small area of metal.

SOFT TOUCH BEAM DELIVERY (0% Beam Diameter Variance)

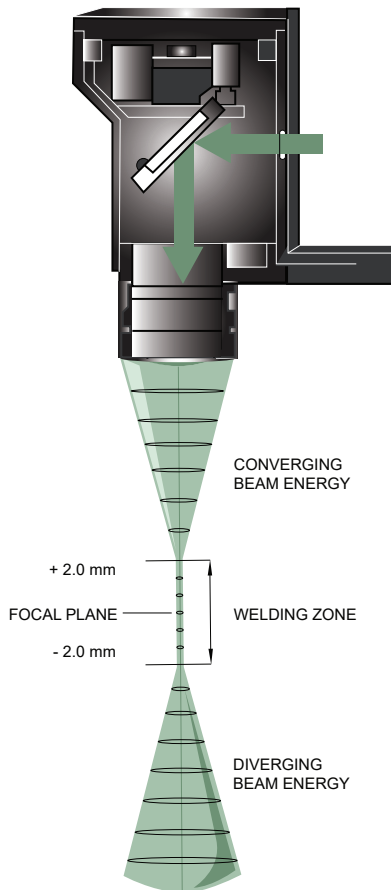

90° or 105° Delivery Systems

THE POWER OF HOT LIGHT

The benefit of this technology is that very little heat is generated at the weld point, allowing users to easily weld 0,05 (.002") away from the most complicated and intricate component parts without damaging heat sensitive materials.

LaserStar Technologies' development of the "free-moving" concept enable users to eliminate costly fixturing devices, benefit from pin-point accuracy, increase the range of assembly and repair applications and minimize the potential hazards of heat damage. The resulting weld is considerably stronger than a traditional solder joint.

PRECISION AND ACCURACY

Operators hold parts in their hands while viewing the application through a stereo-microscope. An internal cross-hair allows the operator to easily align and weld the parts at the correct location.

- ★ **Easy To Use...**
- ★ **Simple to Maintain...**
- ★ **Low Cost of Ownership**



LASERSTAR
ACADEMY™

Our education courses are designed to provide you with a solid foundation of fundamental laser skill sets to immediately gain a revenue impact with your new laser device.

LaserStarAcademy.com

Technical Specifications at www.LaserStar.net

01-10-25

SOFT-TOUCH™ RESONATOR TECHNOLOGY

LaserStar's **Soft-Touch™ Beam Enhancement Resonator Technology** minimizes the impact of thermal lensing and greatly reduces the effects on the beam axis, producing an improved beam shape that can be focused to very small spot sizes while enhancing the overall weld quality.



One can see from the Soft-Touch™ Technology image that a softer beam profile is generated, greatly reducing the effects of the peak energy on the beam axis which often can splash metal, blow holes or damage heat-sensitive materials.

Thermal lensing is common in high-power laser systems. The heating of the gain medium (peak energy) is hotter on the beam axis compared to the outer regions. Consequently, thermal lensing can often cause inconsistent results when applied to small, micro-welding applications.

The following Beam View Analyzer illustrations demonstrate the benefits of Soft-Touch™ Technology.

Standard Resonator BeamView

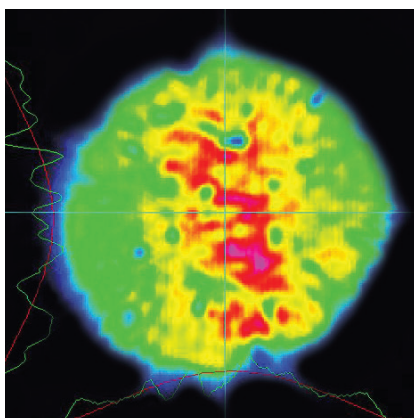

2-D Illustration

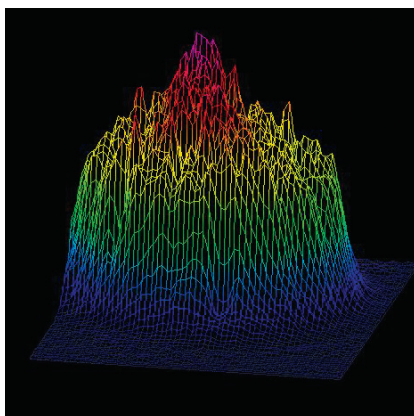

3-D Illustration

Soft-Touch™ Resonator BeamView

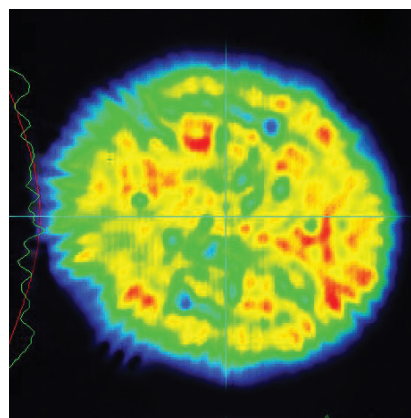

2-D Illustration

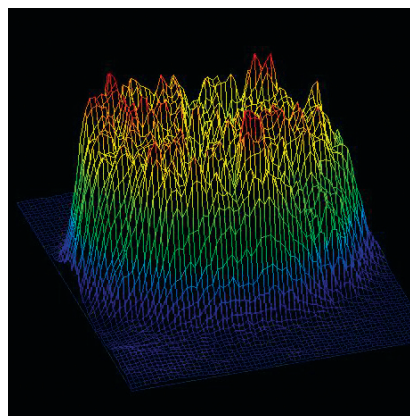

3-D Illustration



PULSE PERFORMANCE PROFILE TECHNOLOGY®

LaserStar's Pulse Performance Profile Technology® (P3) allows user to choose percentage of pulse energy that is released for each half millisecond (.5 ms) section. Each individual section is defined at 25%, 50%, 75% or 100% of total pulse energy output.

The following Pulse Profile illustrations demonstrate the settings of P3® Technology.

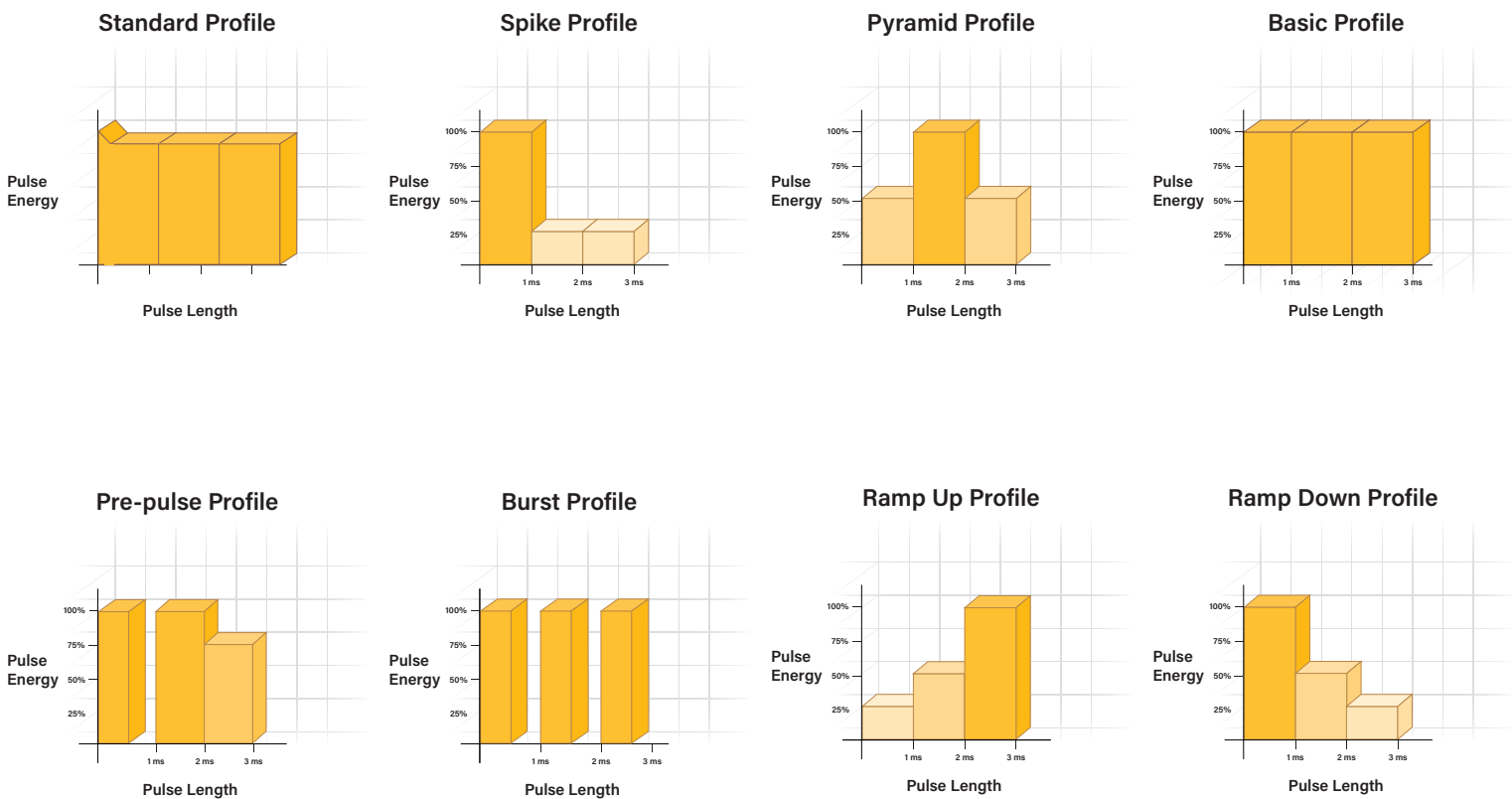

★ When in doubt about which pulse profile may be most beneficial, first set up a process with a Basic Profile and note the energy used (parameter selections) for a particular application.

★ Next, select a recommended pulse profile for the same application and compare the energy used (parameter selections).

★ Finally, compare the two different process results and choose a profile that meets your quality and process speed requirements. **Note:** P3 Technology is only designed for Nd:YAG laser systems.

COMMON WELDABLE ALLOYS

Below is a list of common laser weldable alloys. Want to know if your specific alloy needs will be met with our welders? Contact us today to discuss your specific application requirements.

Silver



Platinum

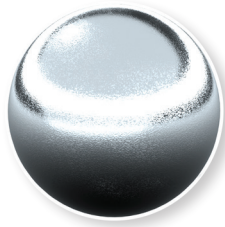

Brass

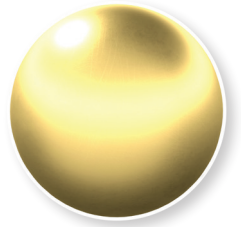

Palladium



Gold

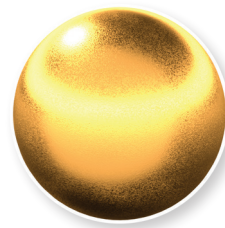

Stainless Steel

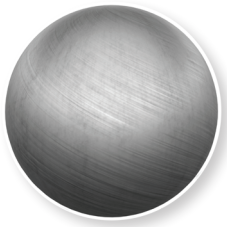

Aluminum

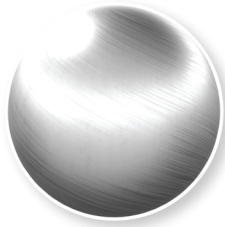

Nickel

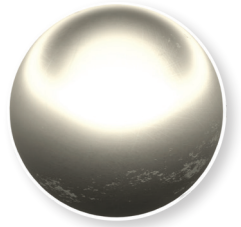

Cobalt Chrome

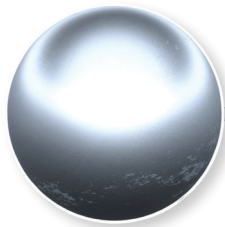

Copper

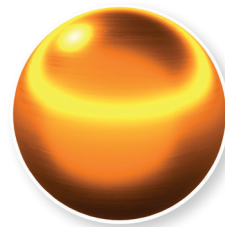

Titanium

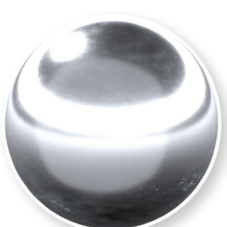

Niobium



Nitinol

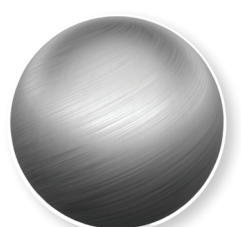

Iconel

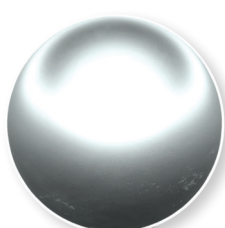

Tantalum

